

NV DELTA ELEKTRONIKA

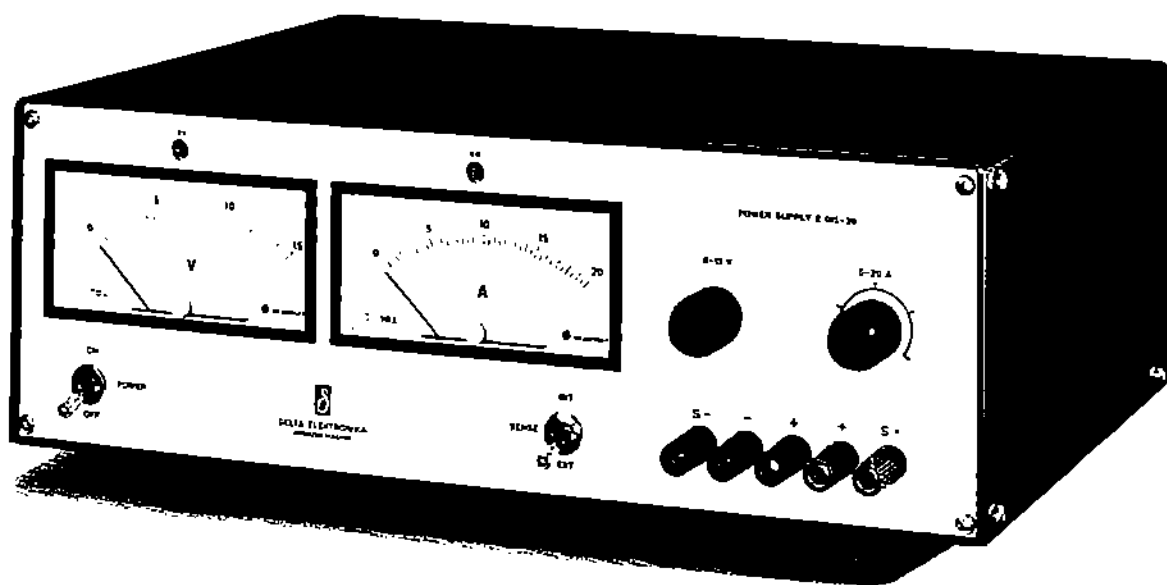

E 015-20 0-15 V, 0-20 A

E 030-10 0-30 V, 0-10 A

E 060-6 0-60 V, 0-6 A

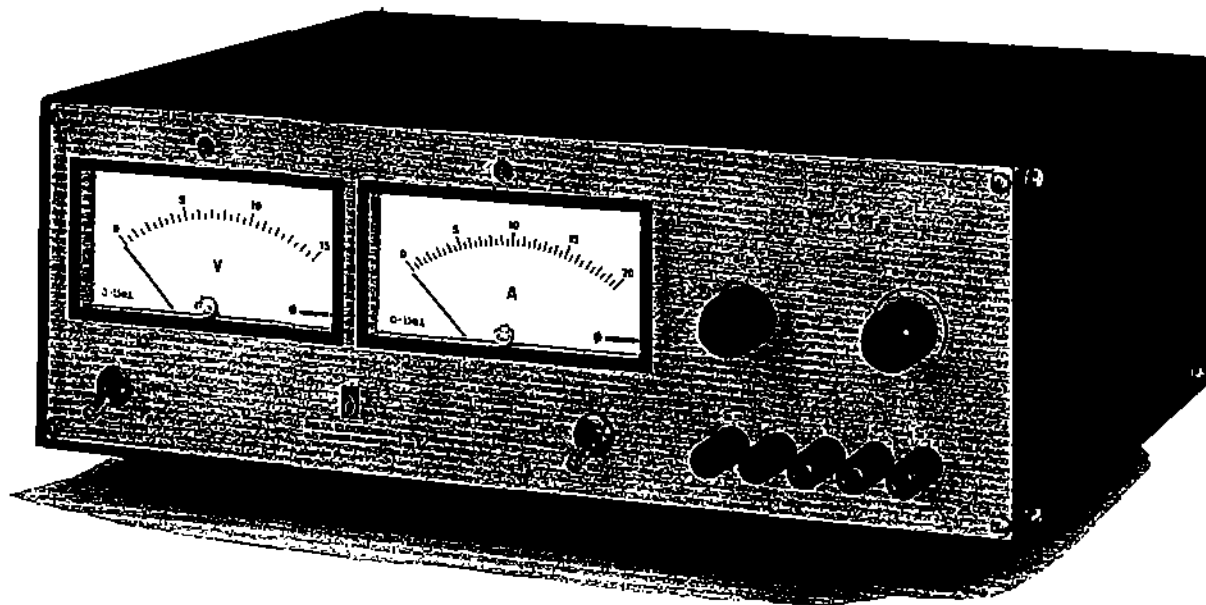

**REGULATED POWER SUPPLIES**

- E 015-20** 0-15 V, 0-20 A
- E 030-10** 0-30 V, 0-10 A
- E 060-6** 0-60 V, 0-6 A

**DESCRIPTION**

Each of these 3 power supplies can be used as a constant voltage source with a limited current or as a constant current source with a limited open voltage.

The change of mode occurs sharply at the crossing of the voltage and current setting.

The mode of operation is indicated above the voltage and current meter.

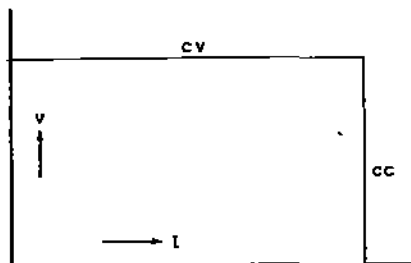

Constant voltage/constant current

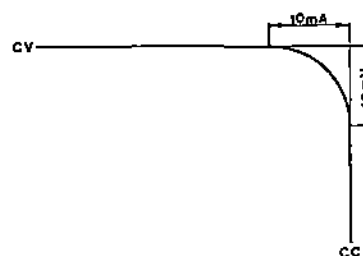

Sharp crossover

A preregulator with silicon controlled rectifiers keeps the rectified voltage in accordance with the output voltage. This results in low dissipation in the power transistors of the series regulator, so that no blower is needed for cooling. The preregulator causes no interference on the mains.

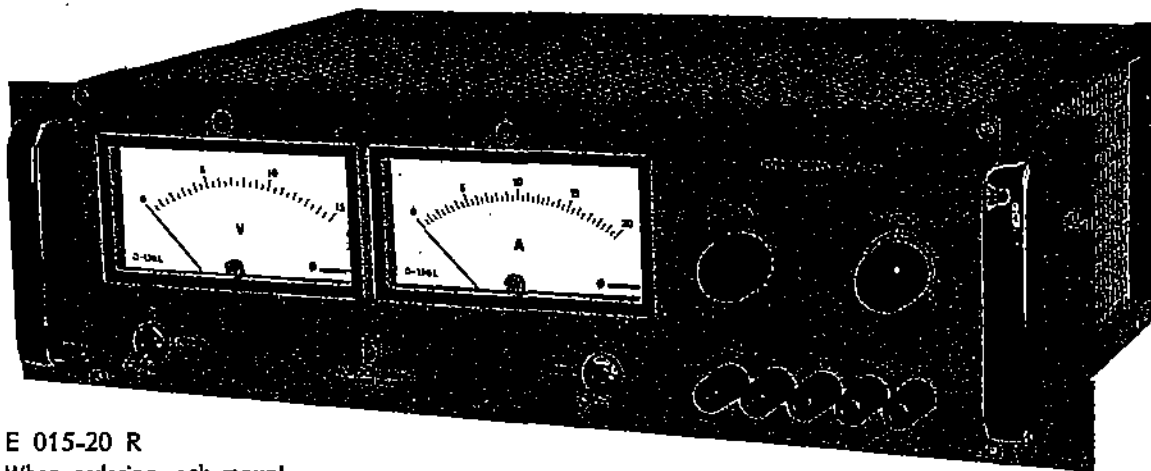

### E 015-20 R

When ordering rack mount  
version add R. to typenumber

There is no overshoot on the output when the power supply is turned on and off.  
The power supply is protected against any overload condition, including sudden and continuous short circuits.

### CONSTANT VOLTAGE OPERATION

<b>Voltage control</b>	10-turn potentiometer, range 0-100 %.
<b>Remote programming</b>	The voltage can be externally programmed by a variable resistor of 0-5 kOhm (0-10 kOhm for E 060-6). The power supply can also be used as a voltage follower. Source resistance maximum 5 kOhm. The programming speed is limited by the speed of the preregulator. At full load the maximum programming speed is 50 V/sec. (measured with triangular waveform).
<b>Remote sensing</b>	Separate amplifier terminals enable the output voltage to be regulated at a remote load point, using two sensing leads and putting the sense switch on external. A voltage drop up to 0.5 Volts in each connecting wire can be compensated.
<b>Voltage regulation</b>	1 mV for a + or - 10 % AC line voltage variation. 10 mV for a 100 % load change (2 mV if measured on the sense points).
<b>Temp. coefficient</b>	Less than $5 \cdot 10^{-5}$ per °C.
<b>Long term stability</b>	Unloaded the drift is less than $1 \cdot 10^{-4}$ per 8 hours under constant ambient conditions after a warm up time of 20 minutes. At full load the temperature in the case rises slowly during the first hour, which causes an extra drift of about $1 \cdot 10^{-3}$ .
<b>Ripple voltage</b>	0.1 mV r.m.s.

**Output Impedance**      Less than 0.1 Ohm up to 100 kHz load frequency.

Typical output impedance versus frequency.

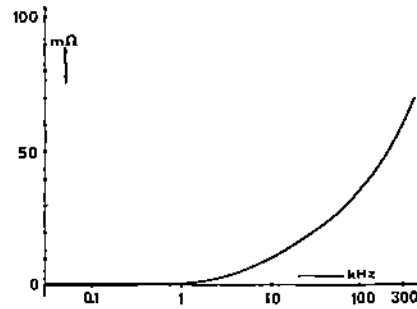

**Recovery time**      25 micro seconds for recovery to within 30 mV of steady state voltage after a step load change from 10 % to 100 %.

### CONSTANT CURRENT OPERATION

**Current control**      Single turn potentiometer, range 0-100 %.

**Remote programming**      The current can be programmed by an external variable resistor of 0-5000 Ohm. Input on the rear panel.  
The output current can also be voltage programmed, input about 0-1 V.

Maximum programming speed	E 015-20	20 A/sec.
(measured with triangular waveform).	E 030-10	10 A/sec.
	E 060-6	6 A/sec.

**Current regulation**      3 mA for a + or - 10 % AC line voltage variation.  
5 mA for a maximum output voltage swing.

**Temp. coefficient**      Less than  $2 \cdot 10^{-4}$  per °C.

**Long term stability**      At 10 % load the drift is less than  $5 \cdot 10^{-4}$  per 8 hours under constant ambient conditions, after a warm up time of 20 minutes.  
At full load the temperature in the case rises slowly during the first 2 hours, which causes an extra drift of  $5 \cdot 10^{-3}$ .

**Ripple current**      1 mA r.m.s.

### REMAINING SPECIFICATIONS

**Input voltage**      110-220 V AC 50 Hz standard,  
117-234 V AC 50 or 60 Hz also available.

**Parallel and series connection**      Special design enables parallel and series operation without any precaution.

<b>Ambient temperature</b>	<b>Model</b>	E 030-10	E 015-20 and E 060-6
	100 % load	0-45 °C	0-35 °C
	80 % load	0-50 °C	0-45 °C

- Output terminals** On front and rear panel, isolated from the case.  
Maximum voltage between output terminals and case 500 V.
- Cooling** By natural convection. The air must flow freely through the vertically heat sink for effective cooling.
- Meters** Voltage and current meter, accuracy 1.5 %.
- Finish** Light gray front panel with dark gray case.
- Weight and size** 20 kg, 418 x 140 x 325 mm (bench model).

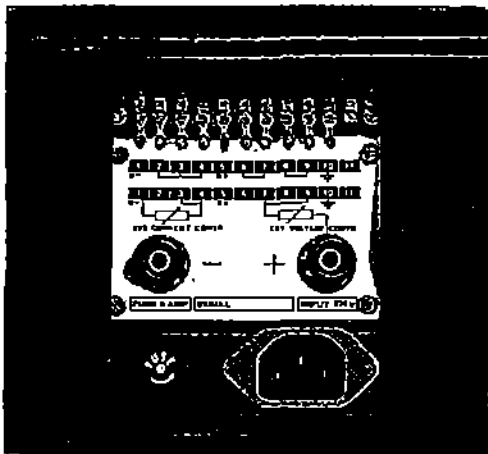

Rear connections for output, sensing, voltage and current programming and AC input.

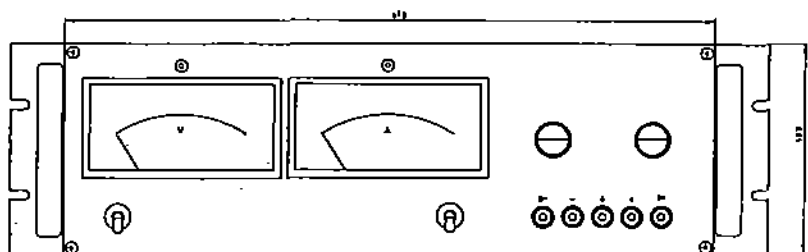
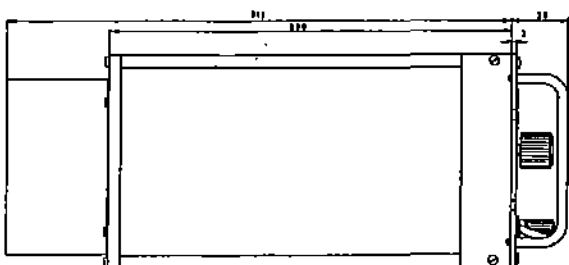
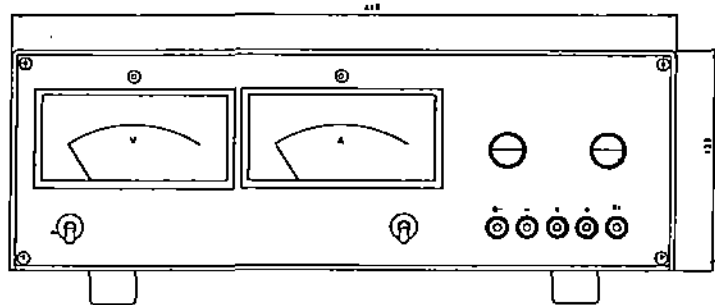
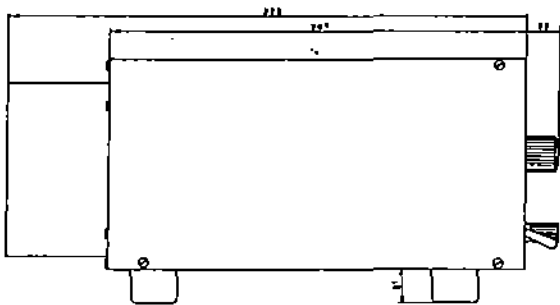

## CIRCUIT DESCRIPTION

The regulation can be divided in two parts: A fast regulation with silicon transistors and a slower pre-regulation with silicon controlled rectifiers.

### SCR Preregulator.

The function of the switching pre-regulator is to keep the heat dissipation in the pass transistor T low.

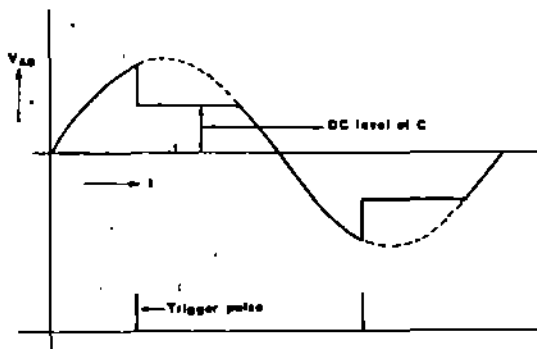
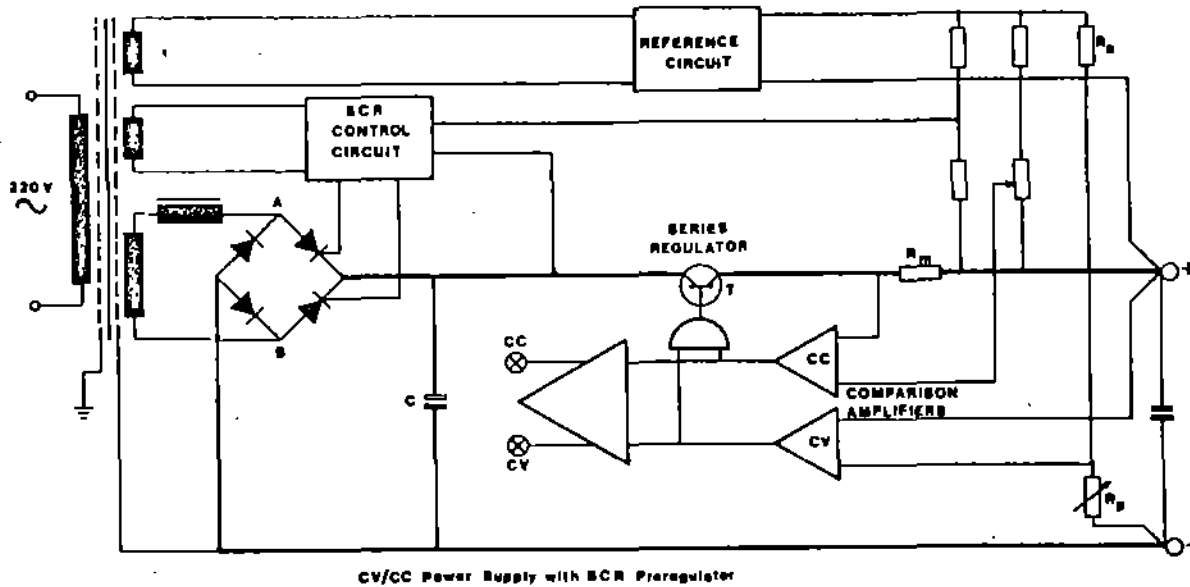

The combined voltage drop across the series regulator and the current monitoring resistor is compared with a part of the reference voltage and the error voltage is converted into a time shift of the firing pulses of the SCR's. This causes a voltage change across capacitor C in order to keep the voltage across the series regulator constant.

The voltage across the series regulator at maximum output current is about 3 Volts.

The choke between the transformer and the rectifier circuit reduces the peak current through the SCR's and also suppresses interference to a very low level.

### Constant voltage regulation

A comparison bridge is formed with the resistors  $R_S$ ,  $R_P$ , the reference voltage and the output voltage.

The error voltage is amplified by the CV comparison amplifier and drives the series regulator. At the condition of balance the output voltage is practically proportional to  $R_P$ .

As long as the constant voltage regulation is active, the constant current regulation is inoperative.

## Constant current regulation

At constant current regulation the voltage drop across  $R_m$ , which is proportional to the output current, is compared with a part of the reference voltage. The error voltage is amplified by the CC comparison amplifier and drives the series regulator in such a way that the voltage across  $R_m$  is constant which means a constant output current.

As long as the constant current regulation is active, the constant voltage regulation is inoperative. The position of the crossover point of CV and CC regulation depends on the settings of the voltage and current controls.

### PART LIST

	E 015-20	E 030-10	E 060-6	
R (Ohm)				
1 =	560	560	560	5W WW
2 =	1.5 k	1.5 k	1.5 k	
3 =	10 k	10 k	10 k	1W
4 =	560	560	560	
5 =	820	820	820	
6 =	33 k	33 k	33 k	
7 =	33 k	33 k	33 k	
8 =	2.2 k	2.2 k	2.2 k	
9 =	330	330	330	
10 =	2.7 k	2.7 k	2.7 k	
11 =	2.2 k	2.2 k	2.2 k	
12 =	10 k	15 k	27 k	
13 =	CR	CR	CR	
14 =	1 k	1 k	1 k	
15 =	10	10	10	
16 =	10	10	10	
17 =	27	27	27	
18 =	10 k	10 k	10 k	
19 =	1.5 k	1.5 k	1.5 k	
20 =	1.5 k	1.5 k	1.5 k	
21 =	5 k	5 k	5 k	20 t. potm.
22 =	1 k	1 k	1 k	
23 =	1.8 k	6.8 k	3.9 k	
24 =	--	5.6 k	--	
25 =	CR	CR	CR	
26 =	22 k	22 k	22 k	
27 =	4.7 k	4.7 k	4.7 k	
28 =	2.2 k	2.2 k	2.2 k	
29 =	1 k	1 k	1 k	
30 =	4.7 k	4.7 k	4.7 k	
31 =	12 k	22 k	47 k	
32 =	1 k	1 k	1 k	
33 =	1 k	1 k	1 k	
34 =	680	680	680	
35 =	4.7 k	4.7 k	4.7 k	
36 =	6.8 k	6.8 k	6.8 k	
37 =	CR	CR	CR	

E 015-20

E 030-10

E 060-6

R (Ohm)

38 =	470	470	470	
39 =	470	470	470	
40 =	1.5 k	1.5 k	1.5 k	
41 =	1.2 k	1.2 k	330	
42 =	27 k	22 k	22 k	
43 =	12 k	12 k	12 k	
44 =	15 k	15 k	15 k	
45 =	1 k	1 k	1 k	
46 =	1 k	1 k	1 k	
47 =	100	100	100	
48 =	680	680	680	
49 =	100 k	100 k	100 k	
50 =	6.8 k	3.3 k	3.3 k	
51 =	CR	CR	CR	
52 =	CR	CR	CR	
53 =	CR	CR	CR	
54 =	100 k	100 k	100 k	
55 =	330	330	330	1W
56 =	220	680	1.2 k	9W WW
57 =	220	680	1.2 k	9W WW
58 =	2.7 m	1.8 m	1.2 m	
59 =	CR	CR	CR	
60 =	100	100	100	
61 =	100	100	100	
62 =	10	10	10	
63 =	10	10	10	
64 =	220	680	1.2 k	9W WW
65 =	0.1	0.2	--	50W WW
66 =	1.5 k	1.5 k	1.5 k	
67 =	0.1	0.2	0.18	50W WW
68 =	1.5 k	1.5 k	1.5 k	
69 =	1 k	1 k	1 k	var.
70 =	470	470	470	
71 =	470	470	470	
72 =	15 k	33 k	68 k	
73 =	390 k	270 k	390 k	
74 =	1 k	1 k	1 k	var.
75 =	5 k	5 k	5 k	var. WW
76 =	5 k	5 k	10 k	10 t. potm.
77 =	47	47	47	5 W
78 =	47	47	47	5 W

C (microfarad)

1 =	2	2	2	70 V
2 =	100	100	100	100 V
3 =	1	1	1	250 V
4 =	6.4	6.4	6.4	150 V
5 =	22	22	22	25 V
6 =	0.000047	0.000047	0.000047	400 V
7 =	0.0033	0.0033	0.0033	500 V
8 =	0.22	0.22	0.22	63 V
9 =	10	10	10	35 V
10 =	0.047	0.047	0.047	250 V



	E 015-20	E 030-10	E 060-6	
C (microfarad)				
11 =	CC	CC	CC	
12 =	0.01	0.01	0.01	250 V
13 =	CC	CC	CC	
14 =	0.01	0.01	0.01	250 V
15 =	47	47	47	63 V
16 =	1000	1000	1000	16 V
17 =	1000	1000	1000	16 V
18 =	1	1	1	250 V
19 =	14000/30 V	5900/75 V	3000/100 V	
20 =	14000/30 V	5900/75 V	3000/100 V	
21 =	14000/30 V	5900/75 V	3000/100 V	
22 =	10	10	10	100 V
23 =	4.7	4.7	4.7	63 V
24 =	4.7	4.7	4.7	63 V
25 =	0.22	0.22	0.22	630 V
26 =	4 x 220/25 V	4 x 100/70 V	4 x 100/ 70 V	

D				
1 =	1N4003	1N4003	1N4003	TI
2 =	W 005	W 005	W 005	GI
3 =	1N4003	1N4003	1N4003	TI
4 =	1N4003	1N4003	1N4003	TI
5 =	ZY 12	ZY 12	ZY 12	ITT
6 =	D13T1	D13T1	D13T1	GE
7 =	ZP 6.2	ZP 6.2	ZP 6.2	ITT
8 =	1N4148	1N4148	1N4148	TI
9 =	1N825	1N825	1N825	Micro S. Corp.
10 =	ZP 6.2	ZP 6.2	ZP 6.2	ITT
11 =	1N4148	1N4148	1N4148	TI
12 =	1N4003	1N4003	1N4003	TI
13 =	1N4003	1N4003	1N4003	TI
14 =	1N4003	1N4003	1N4003	TI
15 =	1N4148	1N4148	1N4148	TI
16 =	ZP 6.2	ZP 6.2	ZP 6.2	ITT
17 =	1N4148	1N4148	1N4148	TI
18 =	1N4148	1N4148	1N4148	TI
19 =	1N4148	1N4148	1N4148	TI
20 =	1N4003	1N4003	1N4003	TI
21 =	1N4003	1N4003	1N4003	TI
22 =	VH 148	VH 148	VH 148	VARO
23 =	2N3896	2N3668	2N3669	RCA
24 =	2N3896	2N3668	2N3669	RCA
25 =	40209 RCA	VTD-200/S	VTD-200/S	VARO
26 =	40209 RCA	in 25	in 25	
27 =	MR1031B	MR1031B	MR1031B	Motorola
28 =	40209 RCA	in 25	in 25	

#### I. C.

1 =	SN72709	SN72709	SN72709	TI
2 =	SN72709	SN72709	SN72709	TI
3 =	SN72709	SN72709	SN72709	TI

E 015-20

E 030-10

E 060-6

T	E 015-20	E 030-10	E 060-6	
1 =	2N3053	2N3053	2N3053	RCA
2 =	BC 182	BC 182	BC 182	TI
3 =	2N3053	2N3053	2N3053	RCA
4 =	BC 182	BC 182	BC 182	TI
5 =	BC 182	BC 182	BC 182	TI
6 =	BC 182	BC 182	BC 182	TI
7 =	3 x 2N3055	2 x 2N3055	2 x 2N3442	RCA
8 =	3 x 2N3055	2 x 2N3055	2 x 2N3442	RCA
9 =	2N3055	2N3055	2N3442	RCA

F = Fuse 5 A delay - 220 V 10 A delay - 117 V  $1\frac{1}{4}'' \times \frac{1}{4}''$

WW = Wire wound resistor

All other resistors metalfilm  $\frac{1}{2}$  W 2%

CR = Calibration resistor

CC = Calibration capacitor

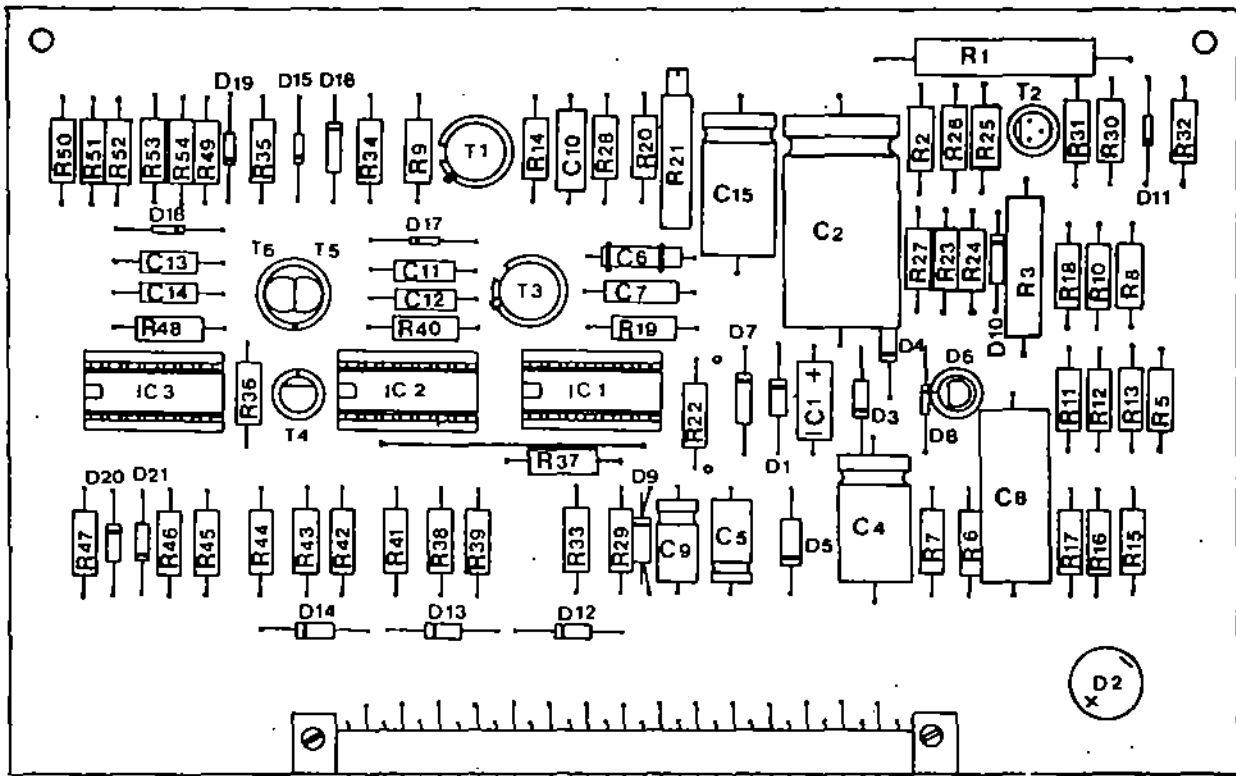

P78

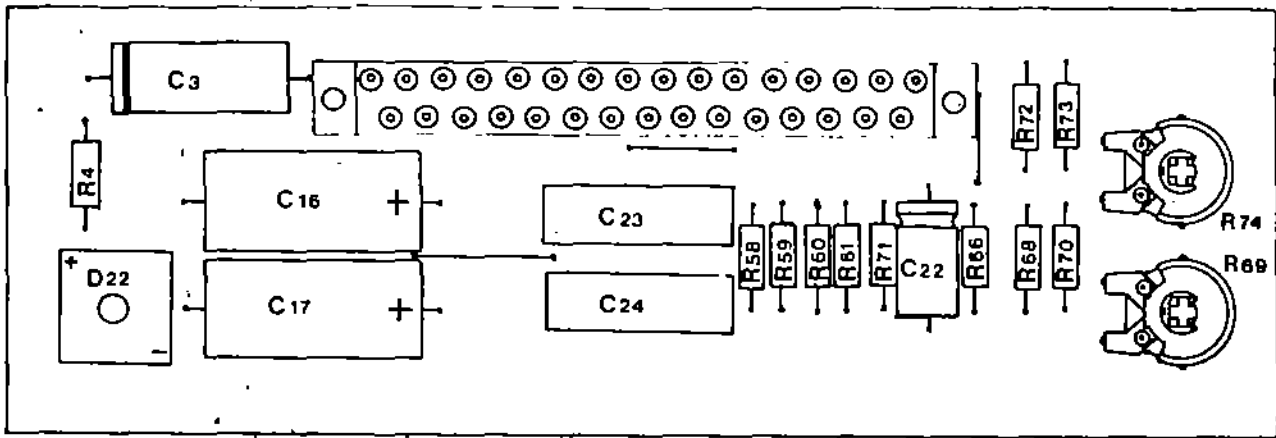

P79

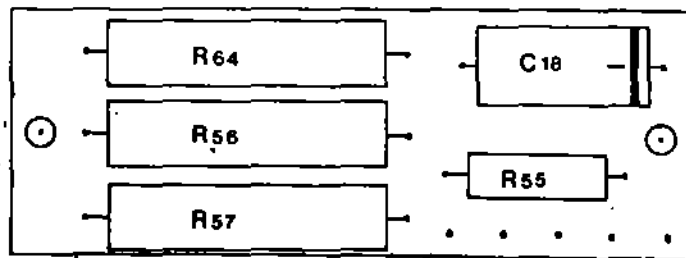

P80

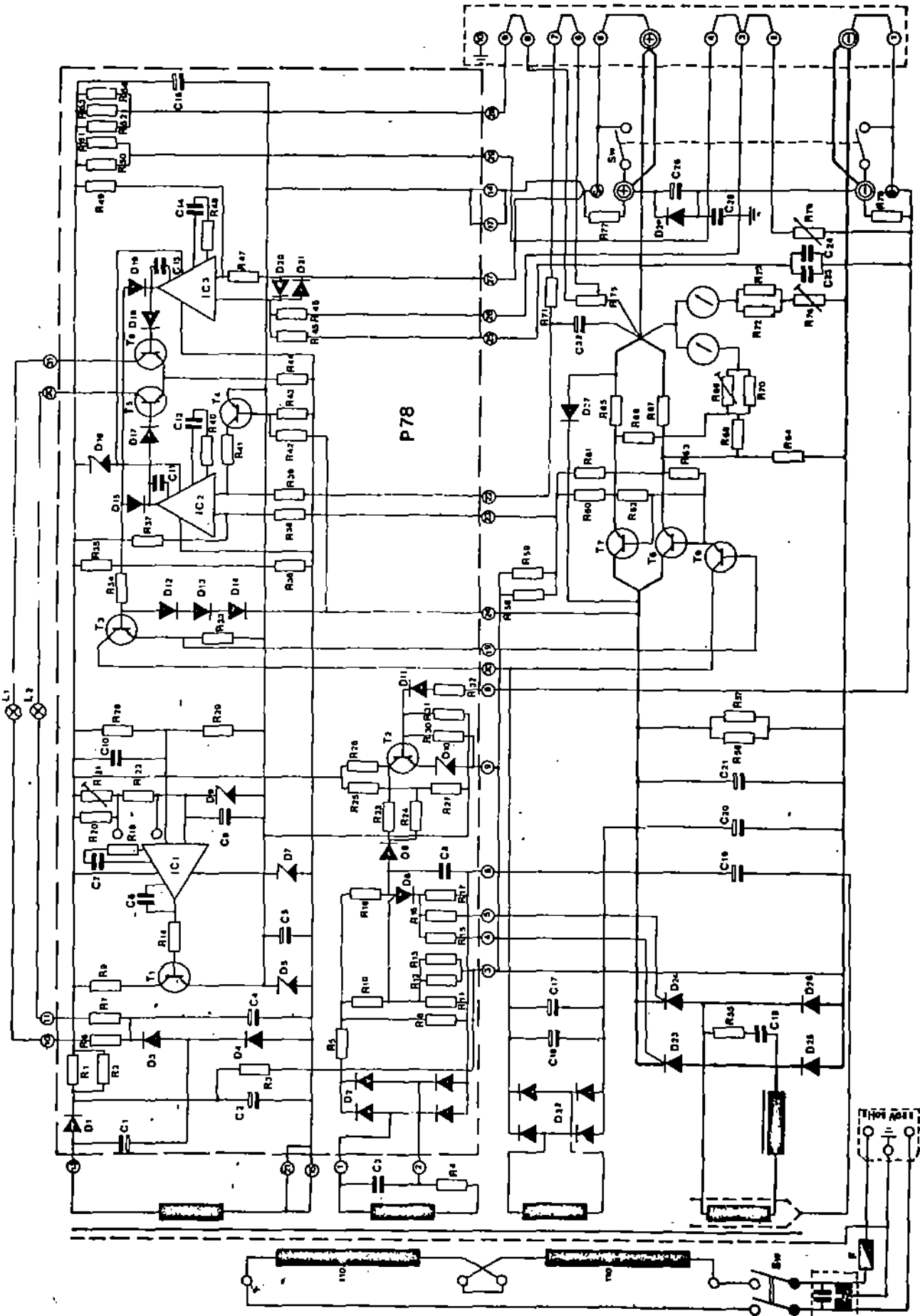

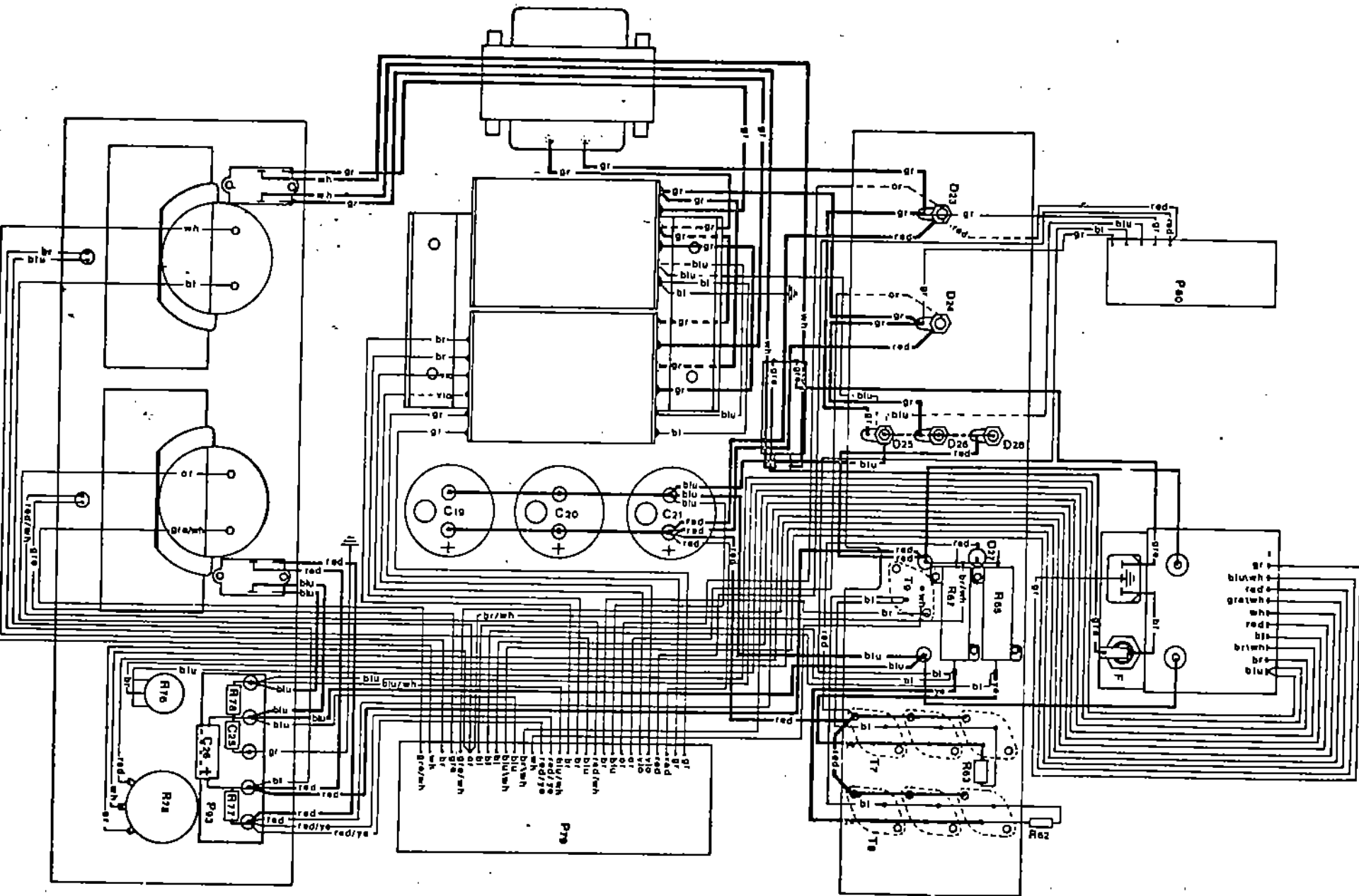

POWER SUPPLIES E 015-20, E 030-10, E 060-6

Series connection

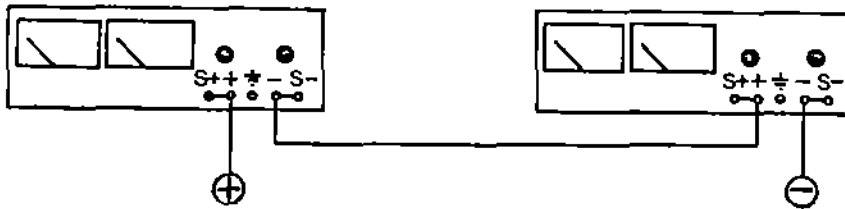

Two or more power supplies of the same model can be connected in series without any precaution by simply connecting the + of the one with the minus of the other power supply. In this case both voltage knobs have to be used to vary the total voltage.

If it is desirable to vary the total voltage with only one knob a special connection can be made between the rear terminal strips.

